

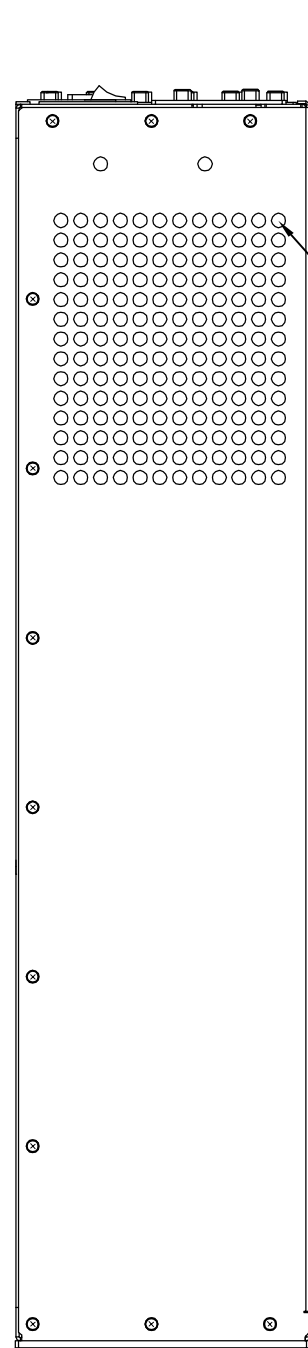

REVISIONS				
REV	DATE	BY	DESCRIPTION	APPROVAL
1	02/23/10	HL	CUSTOMER DWG	---

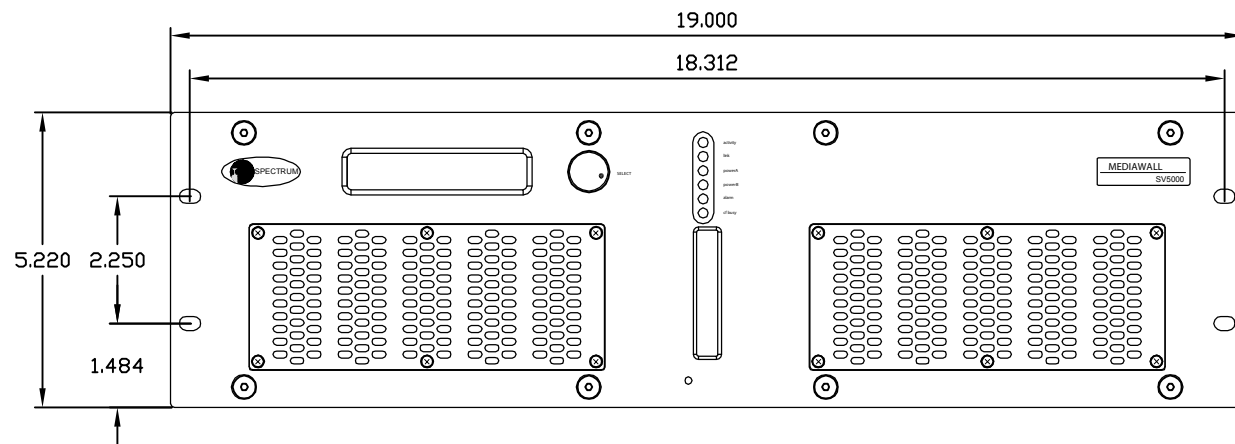

AIR OUTLET
BOTH SIDE

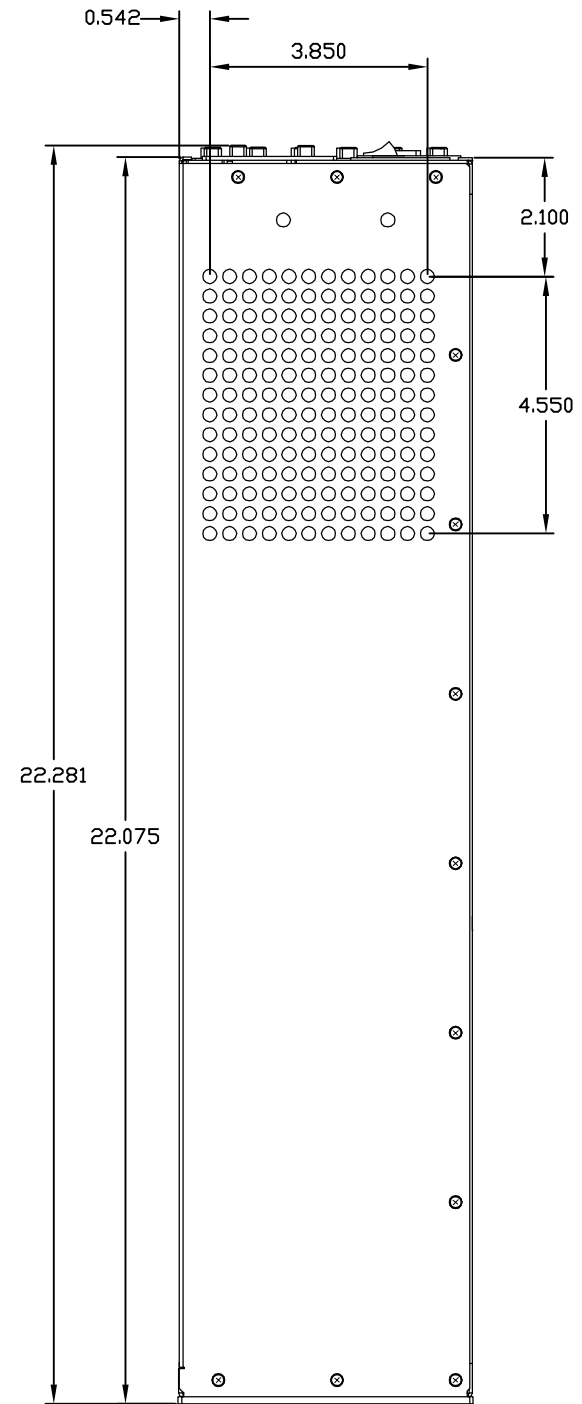
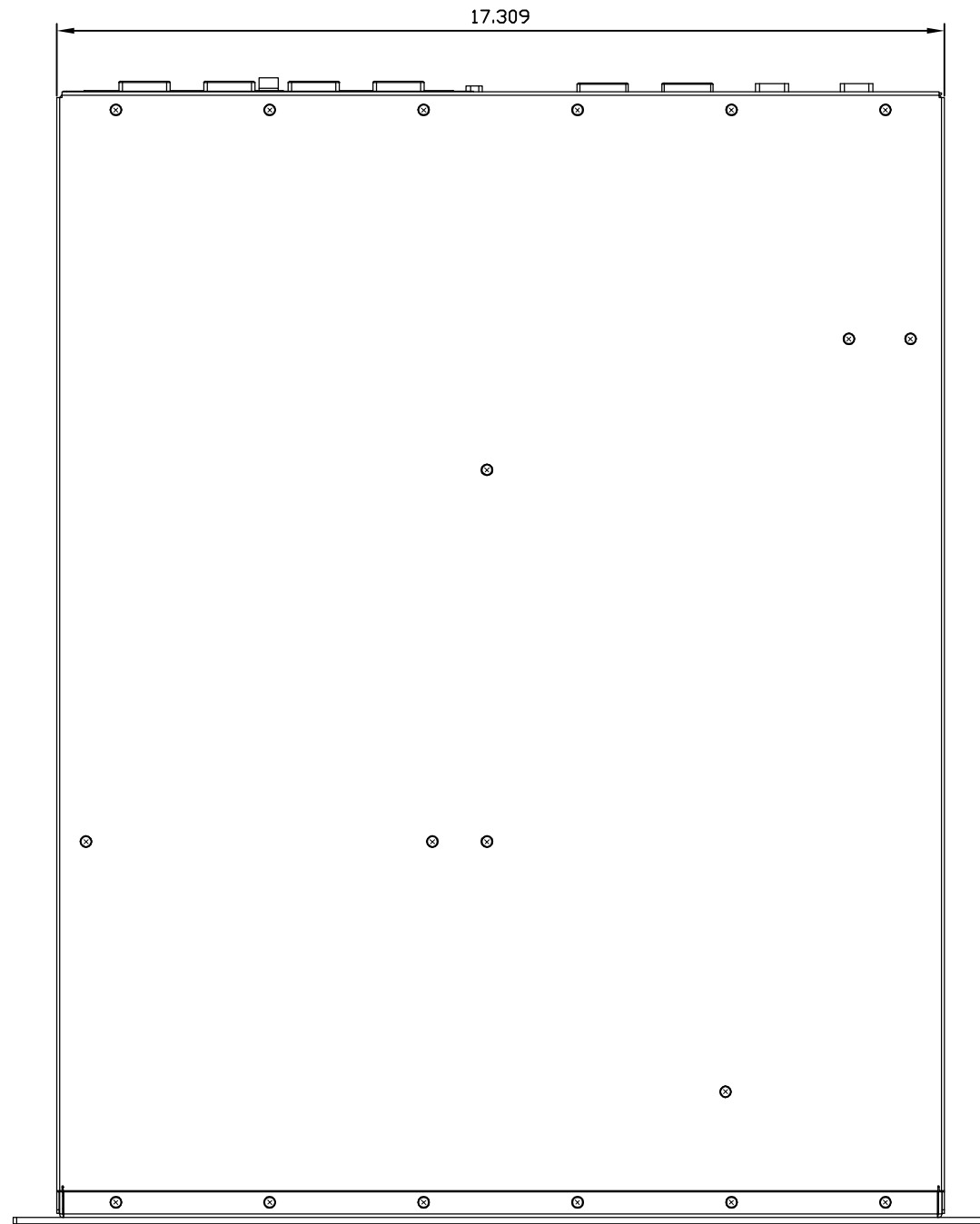

UNLESS OTHERWISE SPECIFIED DIMENSIONS ARE IN INCHES TOLERANCES ARE:		 RGB SPECTRUM 950 MARINA VILLAGE PARKWAY, ALAMEDA, CALIFORNIA	
FRACTIONS ± 1/16	DECIMALS .X ± .03 .XX ± .02 .XXX ± .010		
ORIGINATION	DATE	TITLE: SV5000	
DRAWN HL	02/23/10	SIZE D	SCALE FULL
CHECKED ---	---	DWG NO. 842-9584-02	REV 1
DO NOT SCALE DRAWING		SHEET 1 OF 2	

REVISIONS				
REV	DATE	BY	DESCRIPTION	APPROVAL
1	03/24/09	HL	CUSTOMER DWG	---

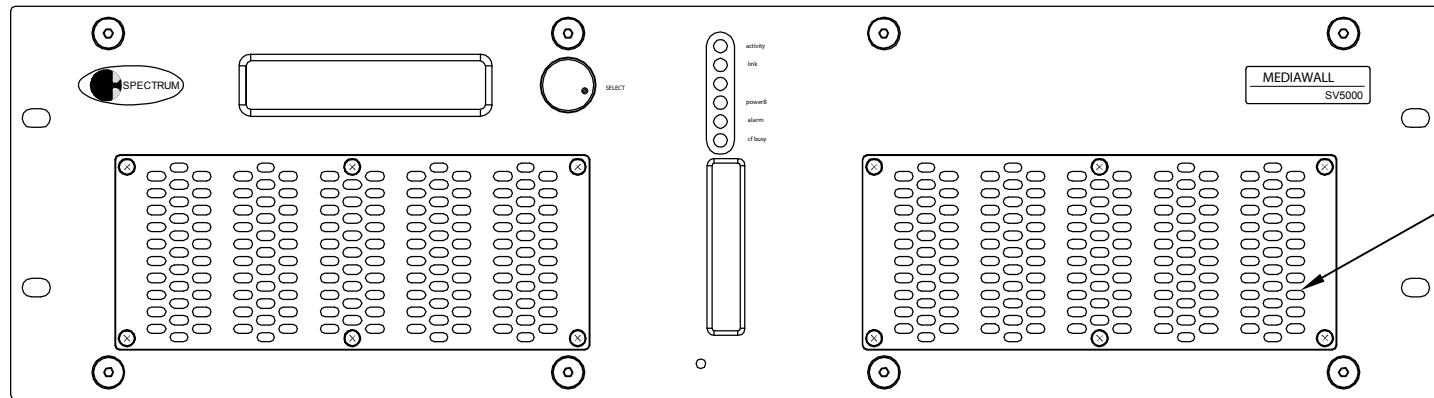

AIR INLET

FRONT VIEW

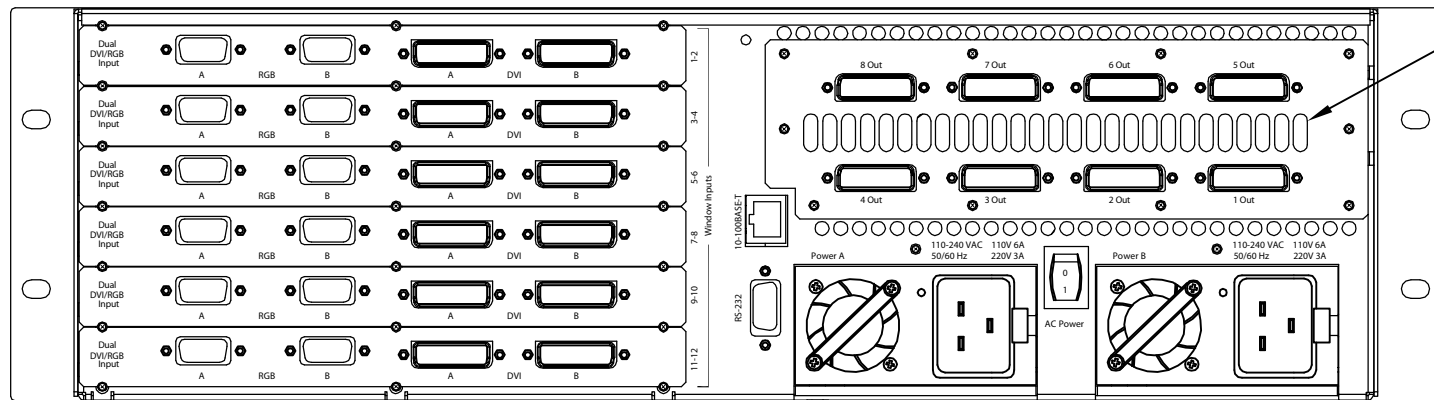

AIR OUTLET

REAR VIEW

UNLESS OTHERWISE SPECIFIED
DIMENSIONS ARE IN INCHES
TOLERANCES ARE:
FRACTIONS DECIMALS ANGLES
± 1/16 .X ± .03 ± 1/2°
 .XX ± .02
 .XXX ± .010



ORIGINATION	DATE	TITLE: SV5000			
DRAWN	HL	02/23/10	SIZE	SCALE	DWG NO.
CHECKED	---	---	D	FULL	842-9584-02
DO NOT SCALE DRAWING					SHEET 2 OF 2